

LYWS2FH

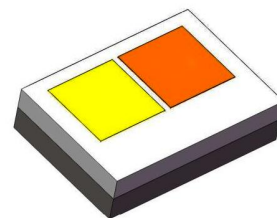

采用表贴式封装，便于集成，良好的散热性能；采用倒装结构芯片，亮度高；白色硅胶填充，透过率高，抗紫外和高温性能好；
SMD package, easy to be integrated, good heat dissipation; flip-chip technology, high optical output efficiency; White silicone sealed, high transmittance, excellent UV protection and thermal stability;

特点 | Features:

- ▲ 封装：陶瓷封装
Package: Ceramic package
- ▲ 视角：120°
Viewing angle: 120°
- ▲ 颜色：Cx = 0.3209, Cy = 0.3323 根据 CIE 1931 (White) & Cx = 0.5772, Cy = 0.416 根据 CIE 1931 (PCA)
Color: Cx = 0.3209, Cy = 0.3323 acc. to CIE 1931 (White) & Cx = 0.5772, Cy = 0.416 acc. to CIE 1931 (PCA)
- ▲ ESD：8 千伏，HBM Class 3B
ESD: 8 kV, HBM Class 3B
- ▲ 认证：AEC-Q102
Qualifications: AEC-Q102
- ▲ MSL：等级 2
MSL: Level 2

应用 | Applications:

- ▲ 汽车信号灯
Automotive lights
- ▲ 电器指示灯
Signaling lamp of apparatus
- ▲ 灯具
Lanterns
- ▲ 仪器、仪表盘背光显示
Dashboard backlight

目录 | Table of Contents

器件最大允许值 Maximum Ratings(White&PCA).....	3
关键指标参数 Characteristics(White).....	4
关键指标参数 Characteristics(PCA).....	5
亮度分档 Brightness Groups(White).....	6
亮度分档 Brightness Groups(PCA).....	6
电压分档 Forward Voltage Groups(White).....	7
电压分档 Forward Voltage Groups(PCA).....	7
色度分档 Chroma Groups(White).....	8
色度分档 Chroma Groups(PCA).....	9
相对光谱分布曲线 Relative Spectral Emission Curve.....	10
辐射特性 Radiation Characteristics.....	11
正向电流-正向电压 Forward current-Forward Voltage.....	12
正向电流-相对光通量 Forward current-Relative Luminous Flux.....	13
正向电流-色度偏移 Forward current-Color Shift Characteristics.....	14
结温-正向电压 Junction Temperature-Forward Voltage.....	15
结温-相对光通量 Junction Temperature-Relative Luminous Flux.....	16
结温-色度偏移 Junction Temperature-Color Shift Characteristics.....	17
最大容许正向电流 Max. Permissible Forward Current(White&PCA).....	18
外形尺寸 Mechanical Dimensions.....	19
推荐焊盘 Recommended Solder Pad.....	20
回流焊曲线 Reflow Soldering Profile.....	21
编带 Taping.....	22
包装信息-产品标签 Packaging Information- Product Label.....	23

器件最大允许值 | Maximum Ratings(White&PCA)

参数 Parameter	符号 Symbol	值 Values	单位 Unit
工作温度 Operating temperature	T_{op}	-40-125	°C
存储温度 Storage temperature	T_{stg}	-40-125	°C
结温 P/N junction temperature	T_j	150	°C
正向电流 Forward current	I_f	1500	mA
脉冲峰值电流 Surge current ($t \leq 10\mu S$; $D=0.005$; $T_s=25^\circ C$)	I_{fm}	1800	mA
反向击穿电压 Reverse voltage	V_R	not designed for reverse operation	V
抗静电电压 ESD withstand voltage (acc. To ANSI/ESDA/JEDEC JS-001-HBM, Class 3B)	V_{ESD}	8	kV

关键指标参数 | Characteristics (Ts=25°C, If=350mA)
(White)

参数 Parameter	符号 Symbol	值 Values	单位 Unit
色温 Color temperature	CCT	typ. 6000	K
色坐标 Chromaticity Coordinate	Cx	typ. 0.3209	
	Cy	typ. 0.3323	
发光角度 Viewing angle at 50% Iv	2θ	typ. 120	deg. [°]
正向电压 Forward voltage		min. 2.60	
	Vf	typ. 3.01	V
		max. 3.40	
光通量 Luminous flux	Φ	typ. 138	lm
反向漏电流 Reverse current	I _R	not designed for reverse operation	μA
热阻 (P/N 结到焊接点) Thermal resistance (P/N junction to soldering point)	R _{thJs ele}	max. 8	K/W

关键指标参数 | Characteristics (Ts=25°C, If=350mA)

(PCA)

参数 Parameter	符号 Symbol	值 Values	单位 Unit
色温 Color temperature	CCT	typ. 1740	K
色坐标 Chromaticity Coordinate	Cx	typ. 0.5772	
	Cy	typ. 0.4160	
发光角度 Viewing angle at 50% Iv	2θ	typ. 120	deg. [°]
正向电压 Forward voltage		min. 2.60	
	Vf	typ. 3.01	V
		max. 3.10	
光通量 Luminous flux	Φ	typ. 98	lm
反向漏电流 Reverse current	I _R	not designed for reverse operation	μA
热阻 (P/N 结到焊接点) Thermal resistance (P/N junction to soldering point)	R _{thJs ele}	max. 10	K/W

亮度分档 | Brightness Groups (Ts=25°C,If=350mA)

(White)

组 Group	符号 Symbol	最小值 Min.	最大值 Max.	单位 Unit
B01	Φ_V	100	110	lm
B02	Φ_V	110	120	lm
B03	Φ_V	120	130	lm
B04	Φ_V	130	140	lm
B05	Φ_V	140	150	lm
B06	Φ_V	150	160	lm

*Ts: soldering point temperature

亮度分档 | Brightness Groups (Ts=25°C,If=350mA)

(PCA)

组 Group	符号 Symbol	最小值 Min.	最大值 Max.	单位 Unit
B11	Φ_V	60	70	lm
B12	Φ_V	70	80	lm
B13	Φ_V	80	90	lm
B14	Φ_V	90	100	lm
B15	Φ_V	100	110	lm
B16	Φ_V	110	120	lm

*Ts: soldering point temperature

电压分档 | Forward Voltage Groups (Ts=25°C, If=350mA)

(White)

组 Group	符号 Symbol	最小值 Min.	最大值 Max.	单位 Unit
V01	Vf	2.6	2.8	V
V02	Vf	2.8	3.0	V
V03	Vf	3.0	3.2	V
V04	Vf	3.2	3.4	V

电压分档 | Forward Voltage Groups (Ts=25°C, If=350mA)

(PCA)

组 Group	符号 Symbol	最小值 Min.	最大值 Max.	单位 Unit
V11	Vf	2.6	2.8	V
V12	Vf	2.8	3.0	V
V13	Vf	3.0	3.1	V

色度分档 | Chroma Groups (Ts=25°C, If=350mA)

(White)

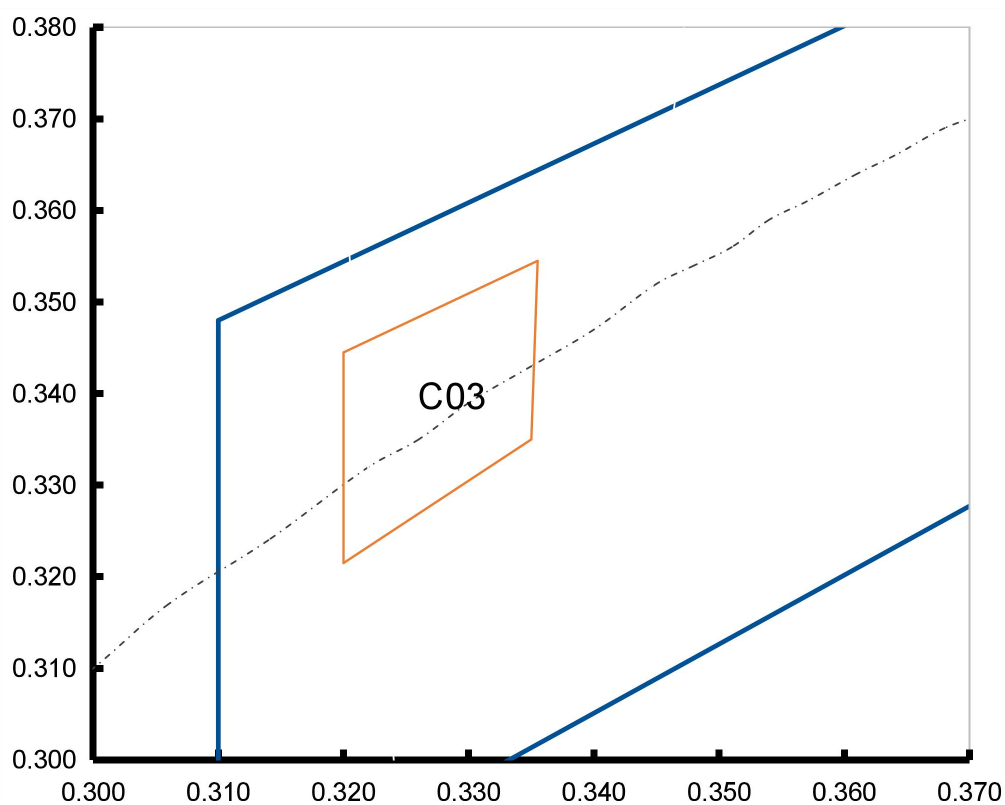

组 Group	符号 Symbol	Cx Cx	Cy Cy	单位 Unit
C03	CCT	0.3200	0.3445	
	CCT	0.3200	0.3215	
	CCT	0.3350	0.3350	
	CCT	0.3355	0.3545	

色度分档 | Chroma Groups (Ts=25°C, If=350mA)

(PCA)

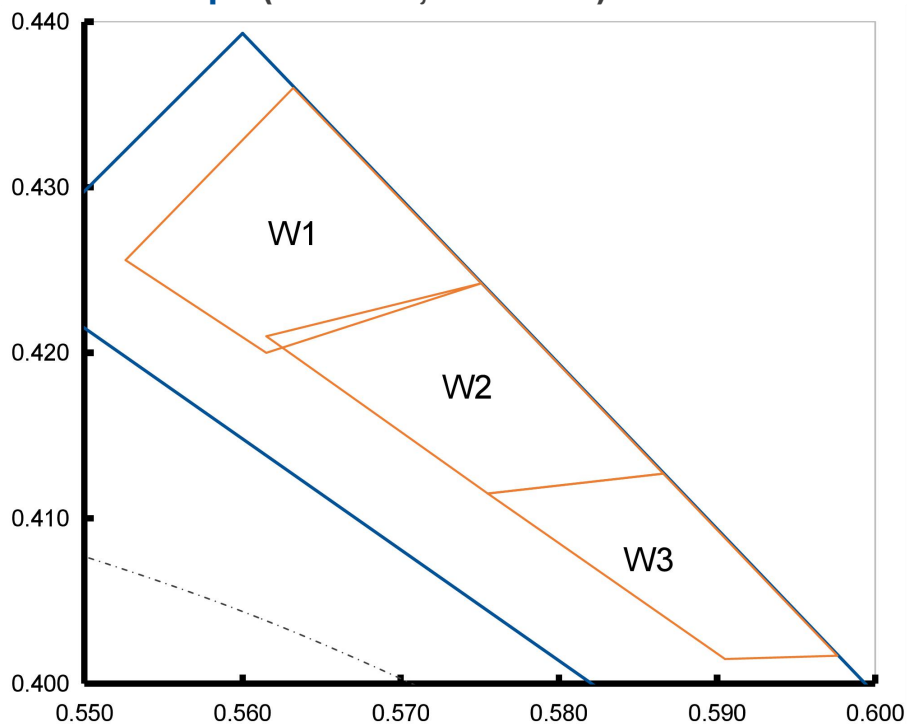

组 Group	符号 Symbol	Cx Cx	Cy Cy	单位 Unit
W1	CCT	0.5526	0.4256	
	CCT	0.5632	0.4360	
	CCT	0.5751	0.4242	
	CCT	0.5615	0.4200	
W2	CCT	0.5615	0.4210	
	CCT	0.5751	0.4242	
	CCT	0.5866	0.4127	
	CCT	0.5755	0.4115	
W3	CCT	0.5755	0.4115	
	CCT	0.5866	0.4127	
	CCT	0.5976	0.4017	
	CCT	0.5905	0.4015	

相对光谱分布曲线 | Relative Spectral Emission Curve (Ts=25°C, If=350mA)

(White)

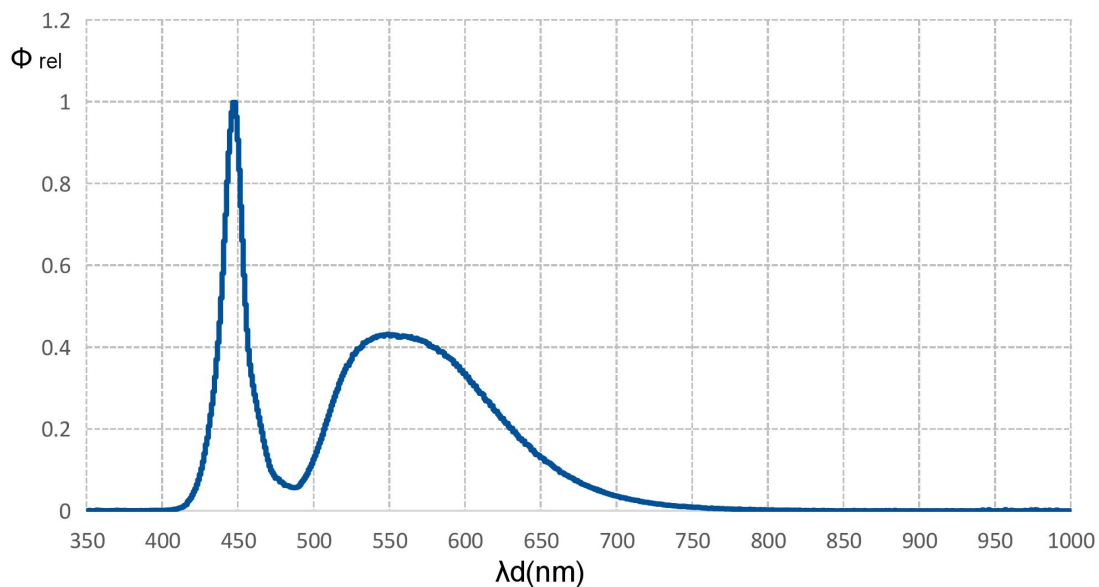

(PCA)

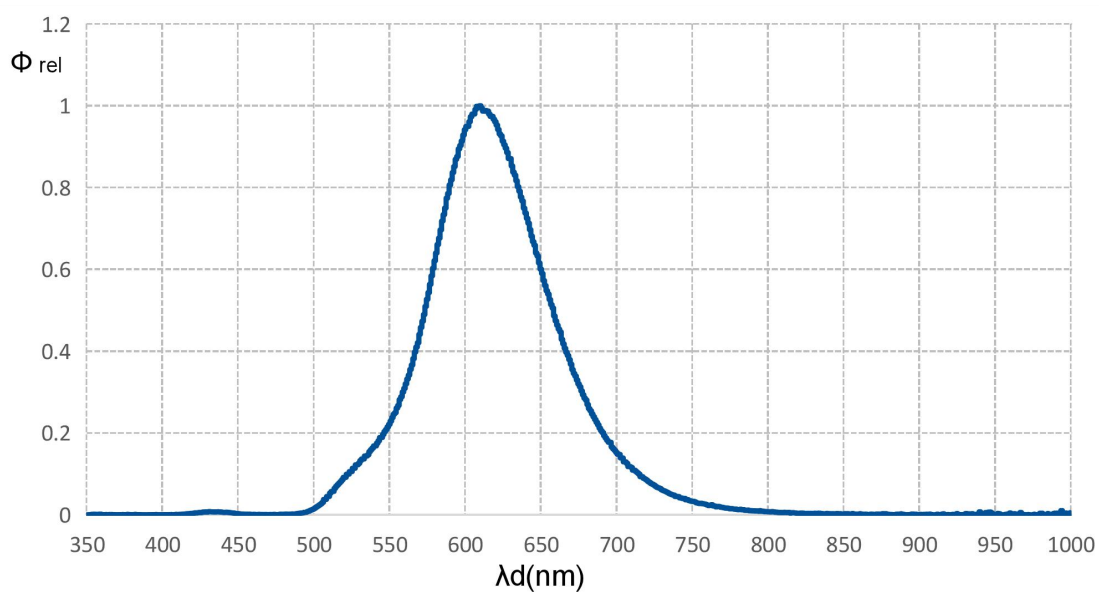

辐射特性 | Radiation Characteristics ($T_s=25^{\circ}\text{C}, I_f=350\text{mA}$)

(White&PCA)

(White)

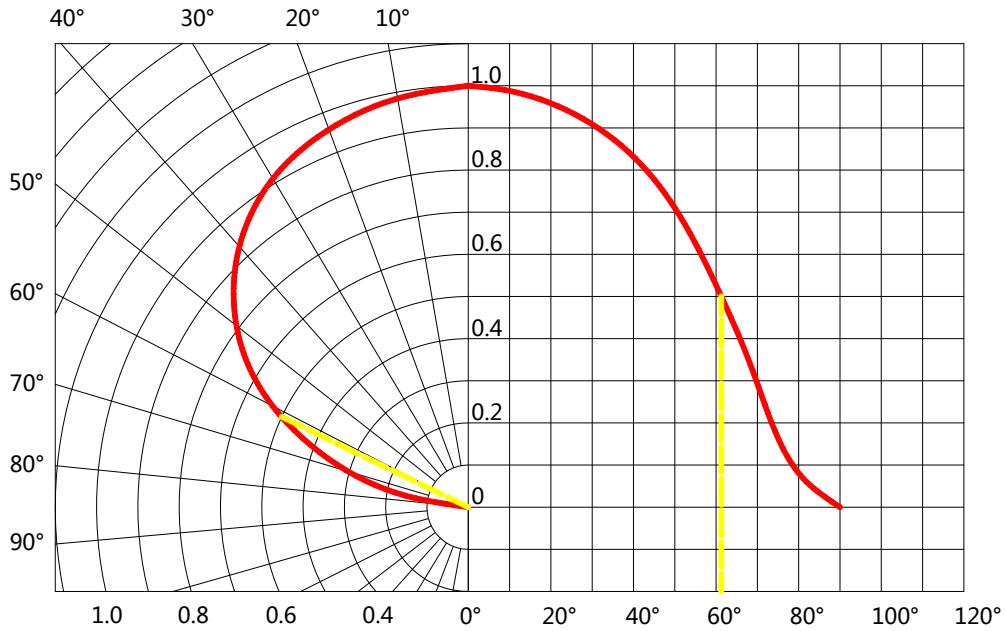

(PCA)

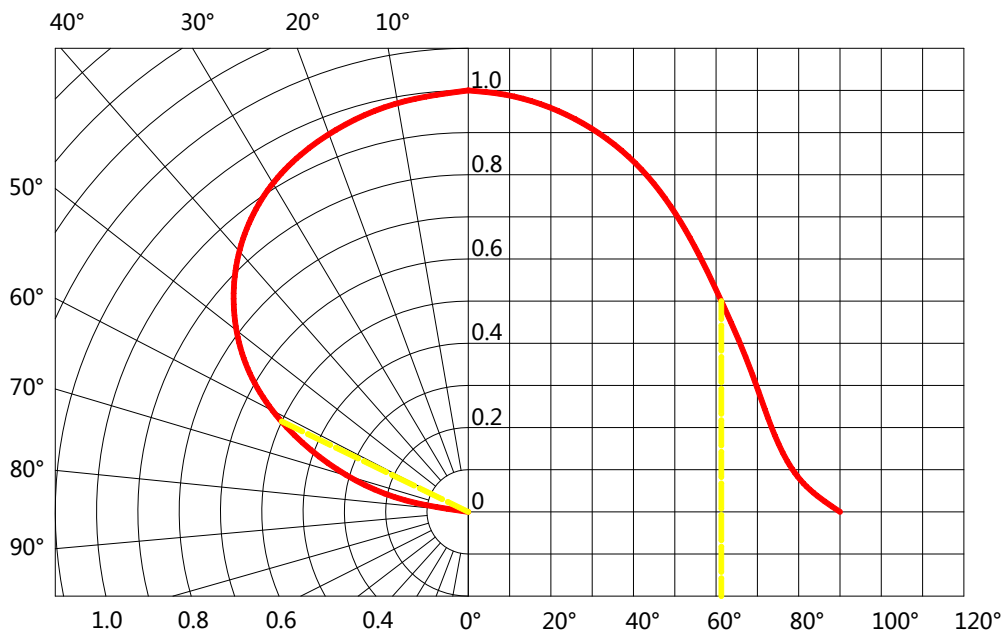

正向电流-正向电压 | Forward current-Forward Voltage (Ts=25°C)

(White)

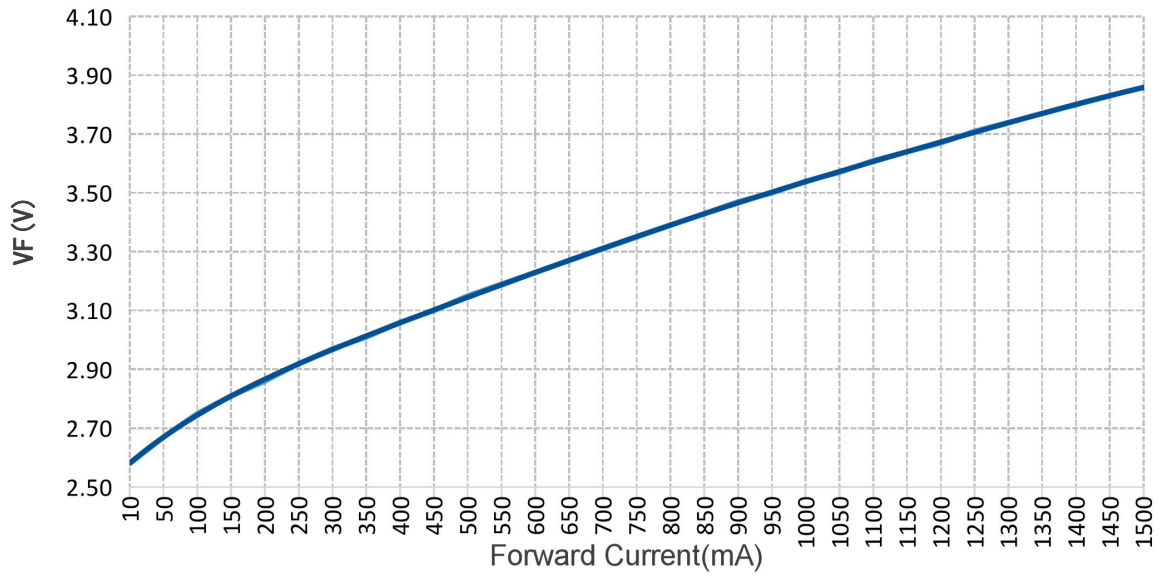

(PCA)

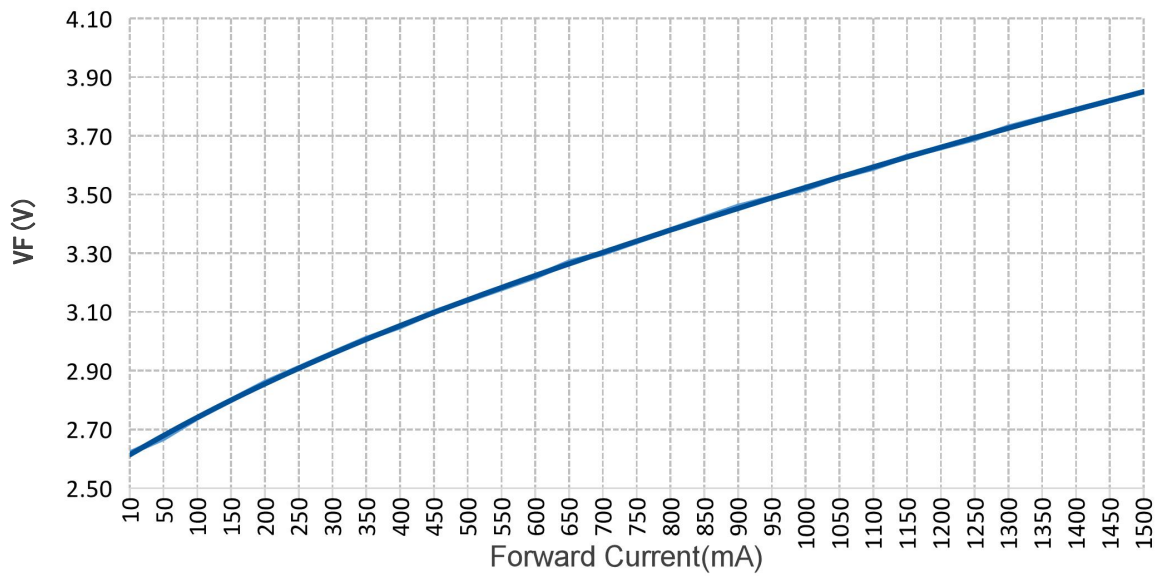

正向电流-相对光通量 | Forward current-Relative Luminous Flux (Ts=25°C)

(White)

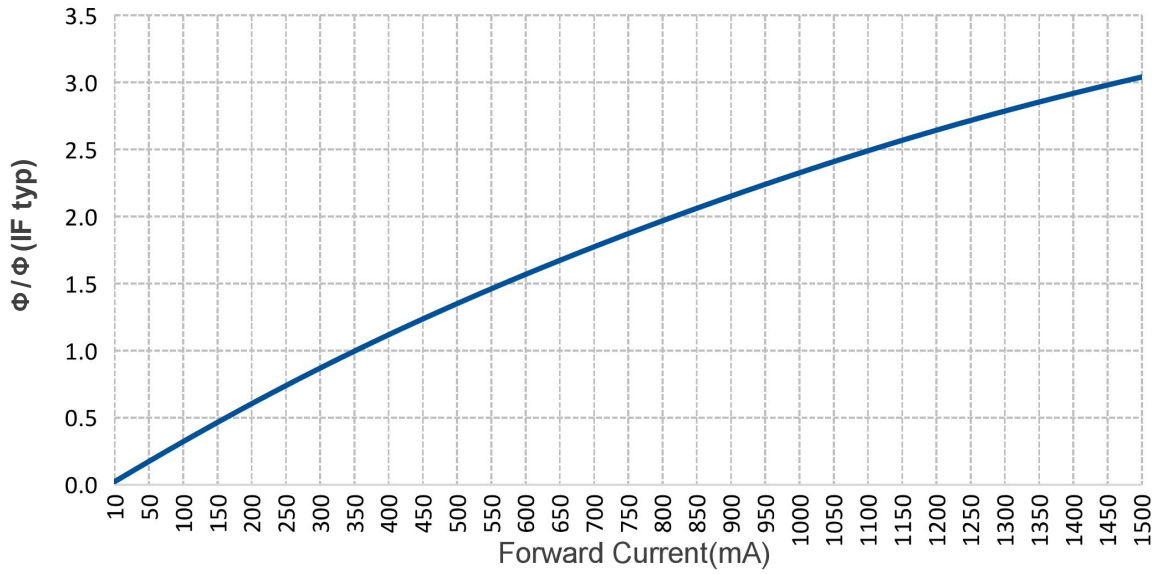

(PCA)

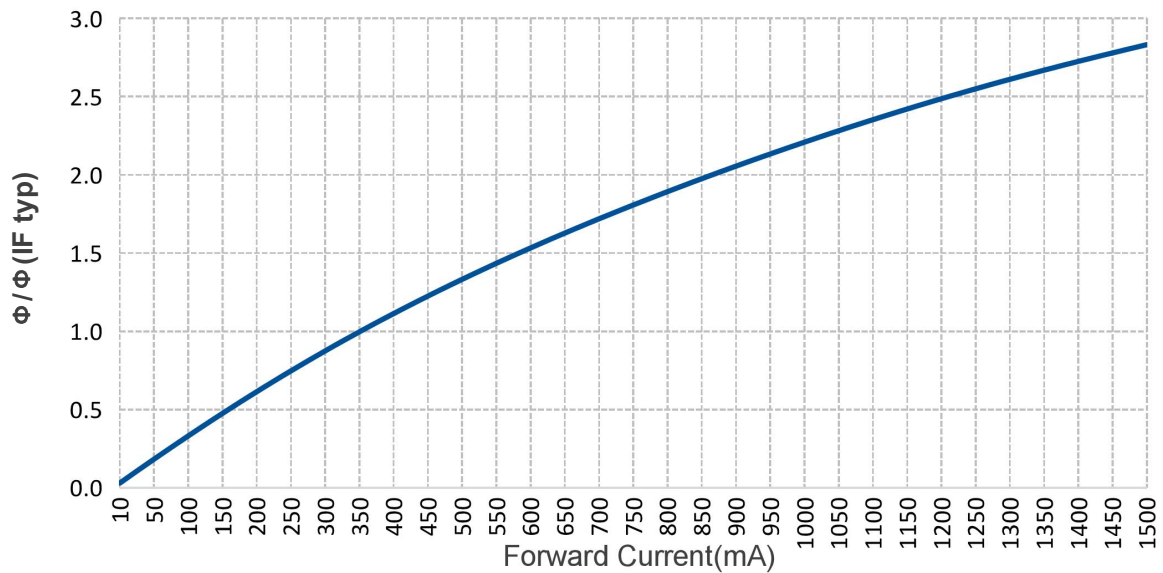

正向电流-色度偏移 | Forward current-Color Shift Characteristics (Ts=25°C)

(White)

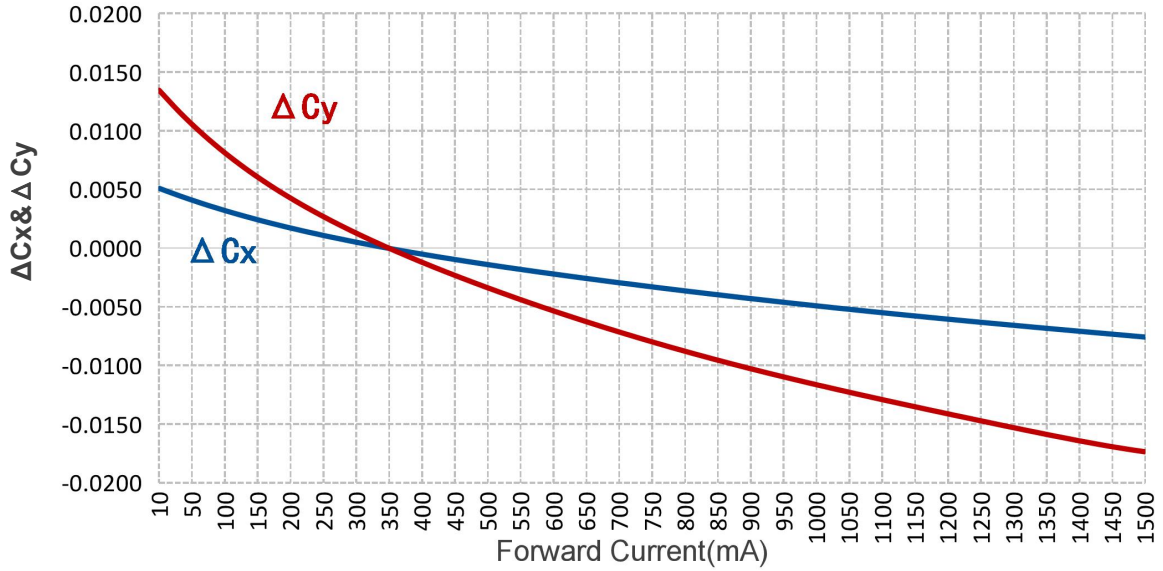

(PCA)

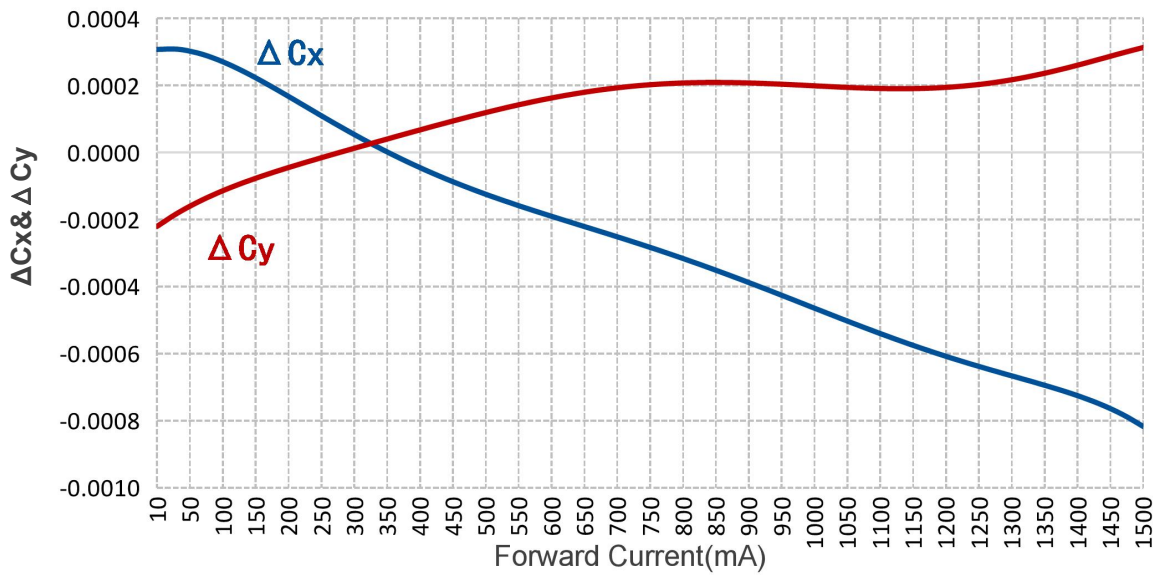

结温-正向电压 | Junction Temperature-Forward Voltage (If=350mA)

(White)

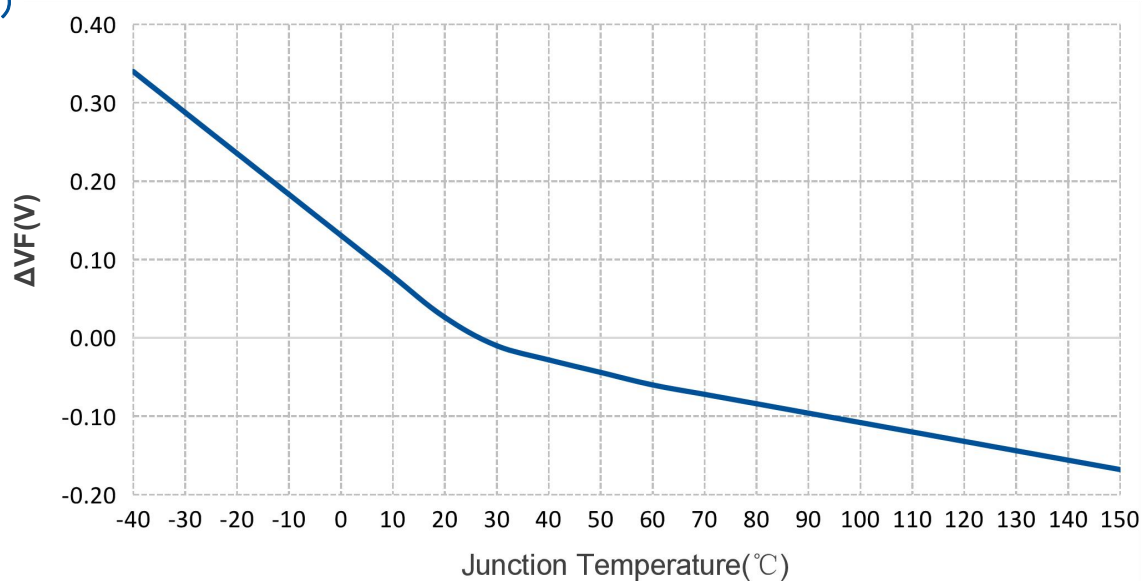

(PCA)

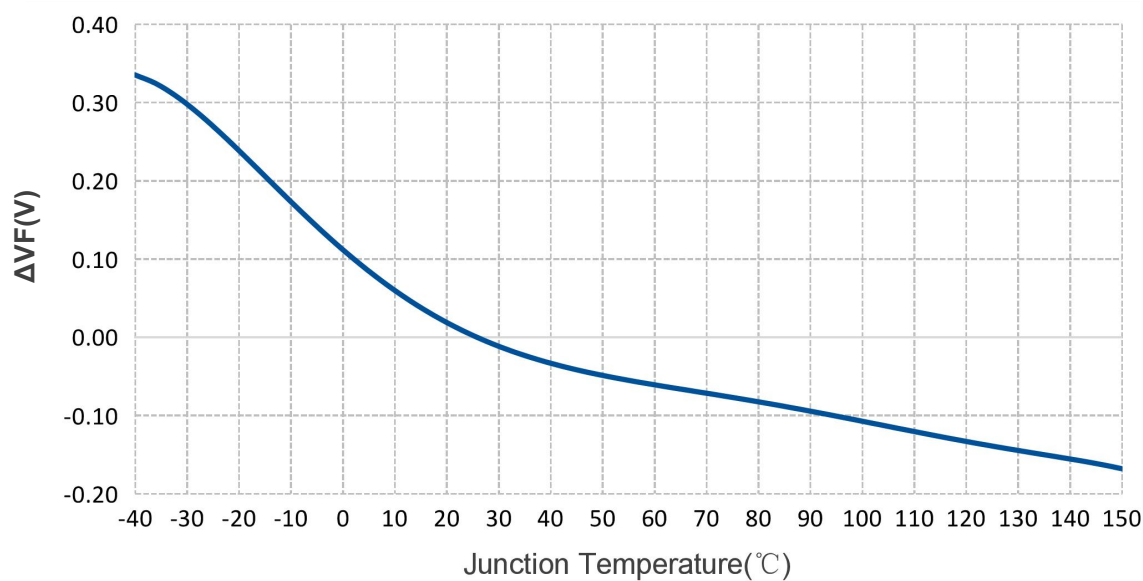

结温-相对光通量 | Junction Temperature-Relative Luminous Flux (If=350mA)

(White)

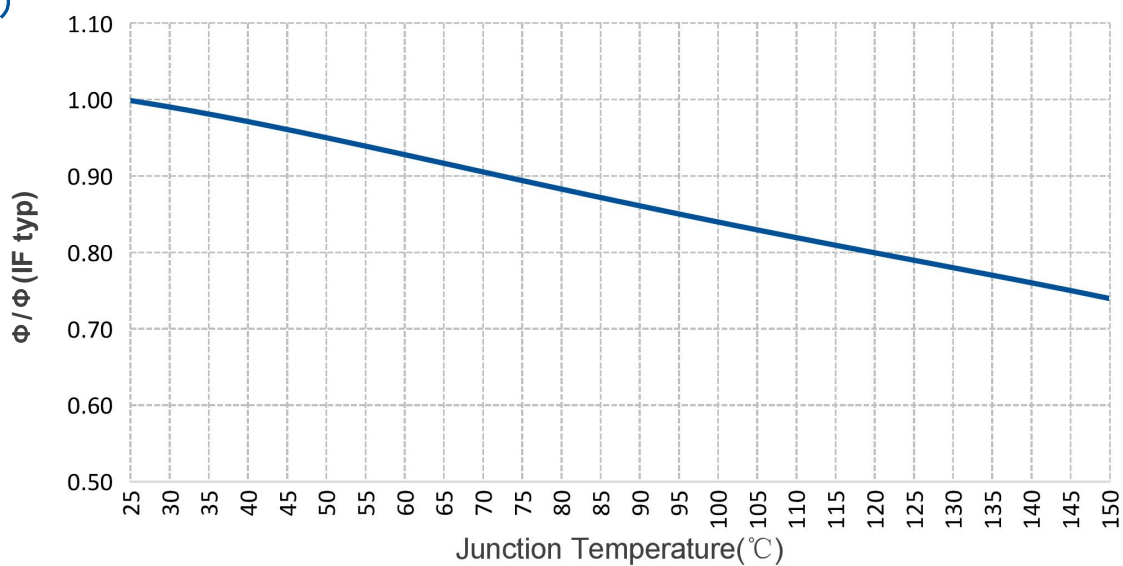

(PCA)

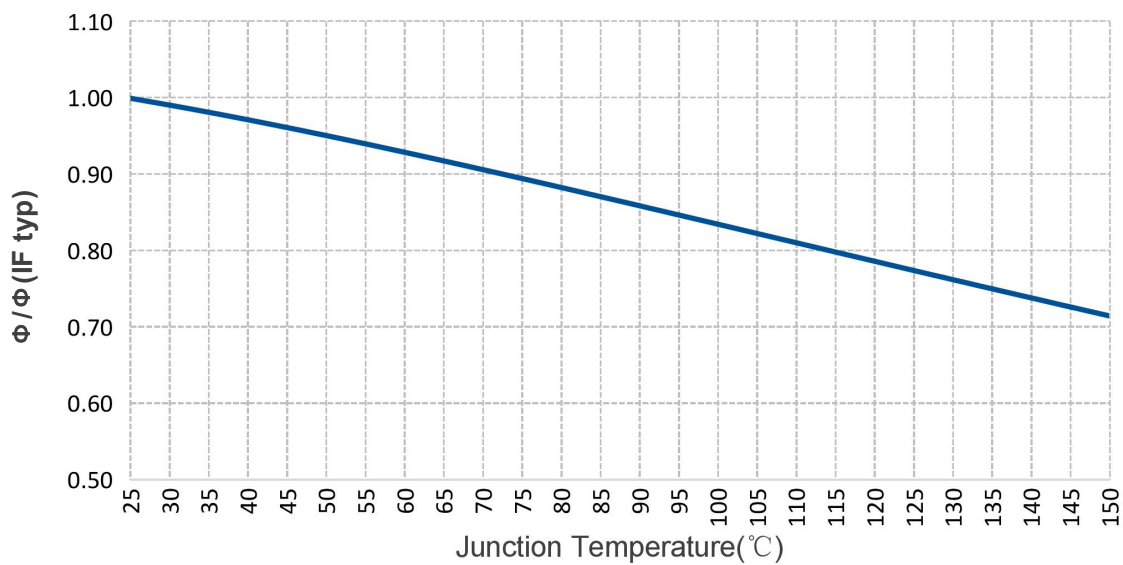

结温-色度偏移 | Junction Temperature-Color Shift Characteristics(If=350mA)

(White)

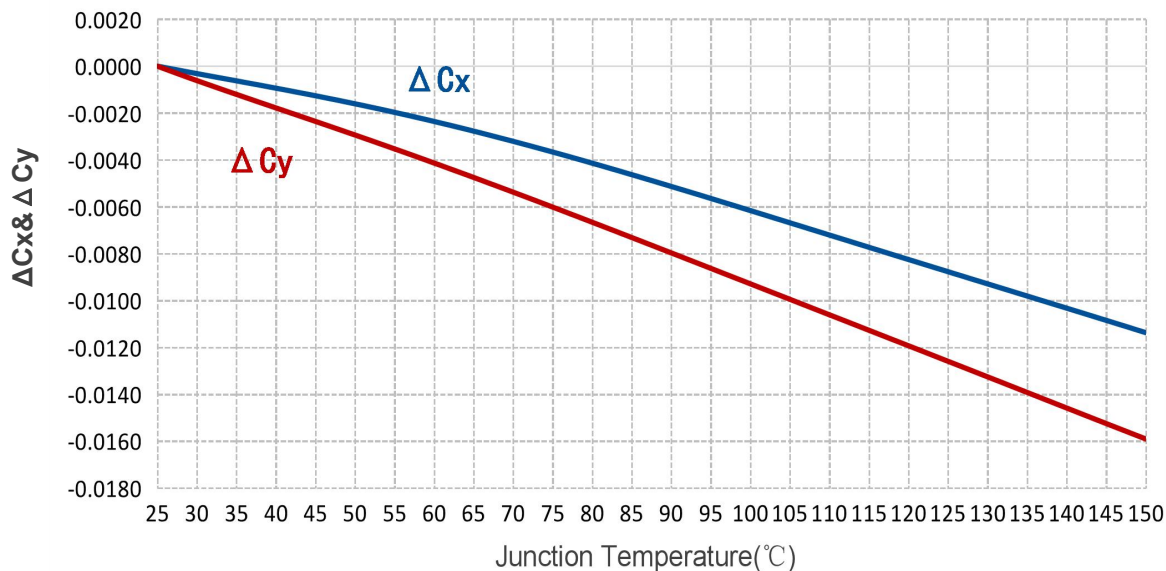

(PCA)

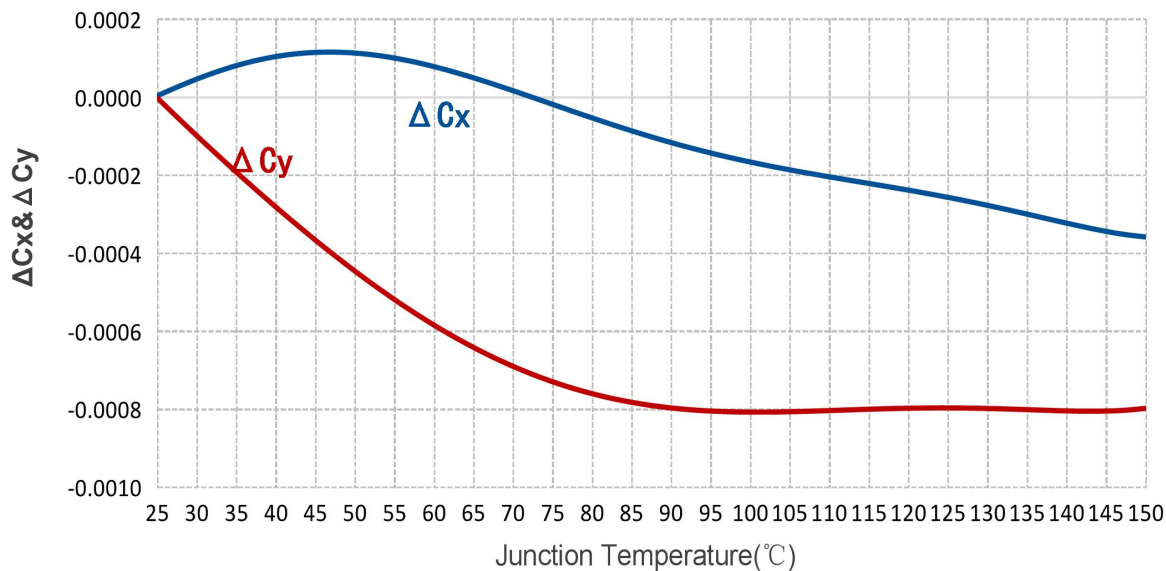

最大容许正向电流 | Max. Permissible Forward Current(White&PCA)

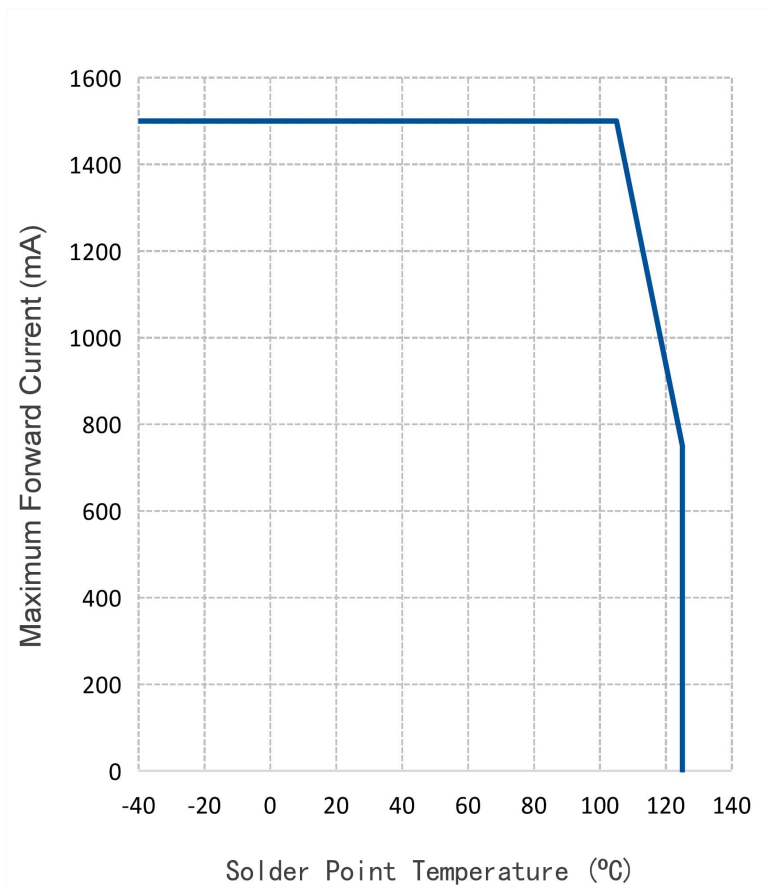

外形尺寸 | Mechanical Dimensions

单位 | Unit: mm

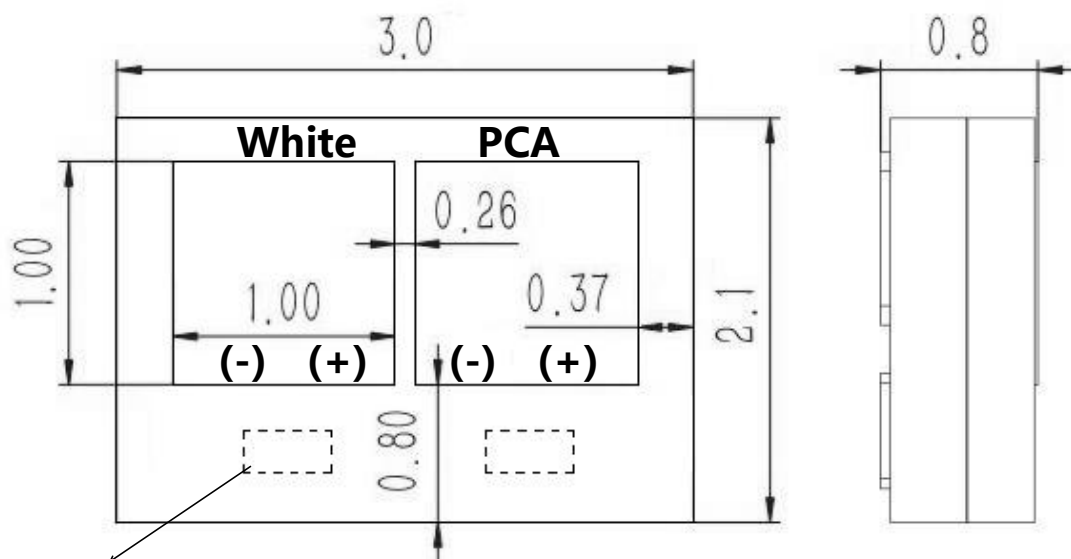

齐纳管 | Zener diode Chip

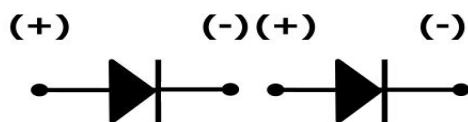
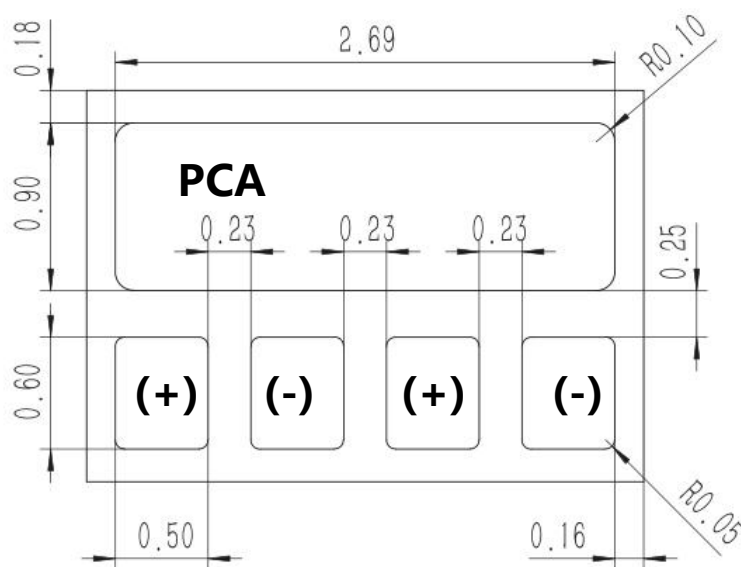

尺寸 Size	公差 Tolerance
.	±0.1mm
*.**	±0.05mm

推荐焊盘 | Recommended Solder Pad

单位 | Unit: mm

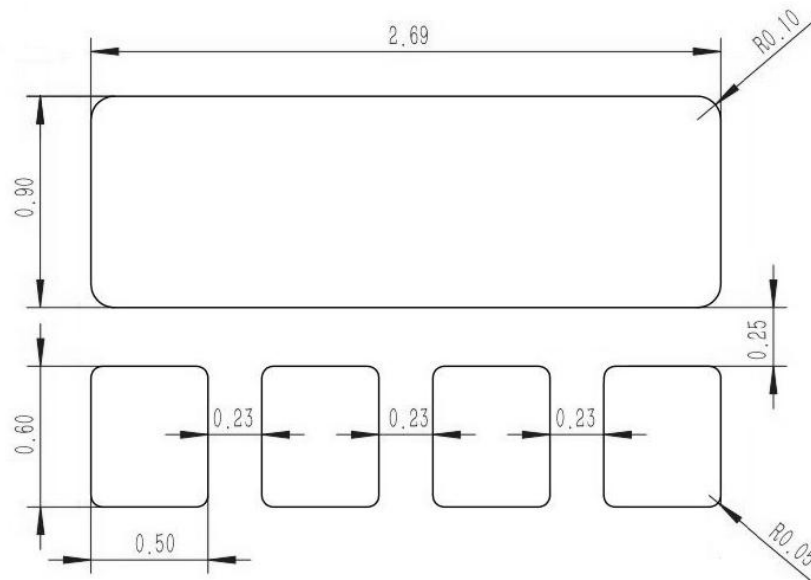

回流焊曲线 | Reflow Soldering Profile

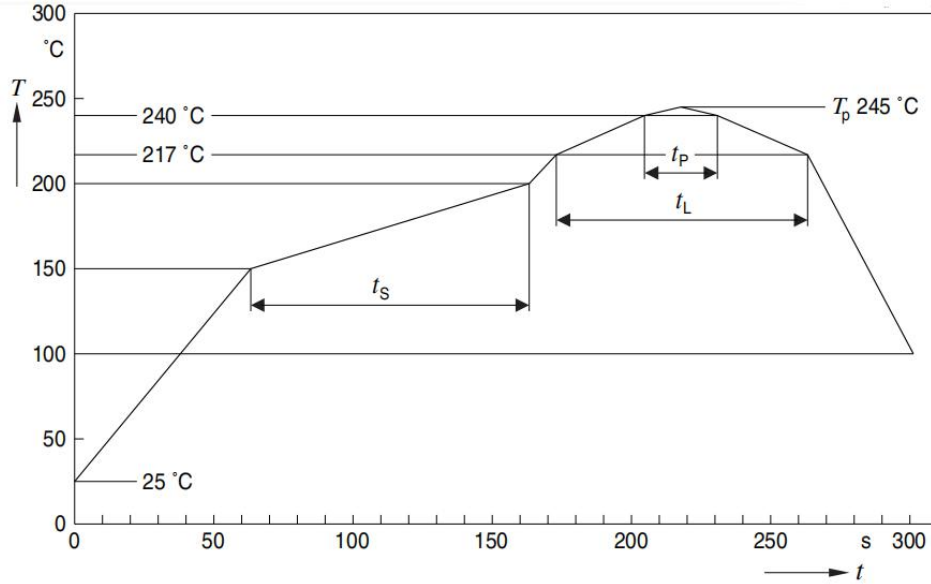

回流焊步骤 Profile Feature	符号 Symbol	无铅回流焊 (SnAgCu) Pb-Free (SnAgCu) Assembly			单位 Unit
		最小值 Min.	设定值 Reco.	最大值 Max.	
预热升温速率 25 °C to 150 °C Ramp-up rate to preheat			2	3	K/s
升温时间 (T _{sm} -T _{smax})	t _s	60	100	120	s
从 T _{smax} 升温到最高温度的速率 Ramp-up rate to peak			2	3	K/s
达到液相的温度 Liquidus temperature			217		°C
在液相温度以上的时间 Time above liquidus temperature	t _L		80	100	s
最高温度 Peak temperature	T _p		245	260	°C
在高于最高温度 5°C 范围内停留的时间 Time within 5 °C of the specified peak temperature TP - 5 K	t _p	10	20	30	s
降到 100°C 的速率 Ramp-down rate* TP to 100 °C			3	6	K/s
从最高温降到 25°C 的时间 Time 25 °C to TP				480	s

*LED complies to MSL Level 2 (JEDEC J-STD-020E)

编带 | Taping

单位 | Unit: mm

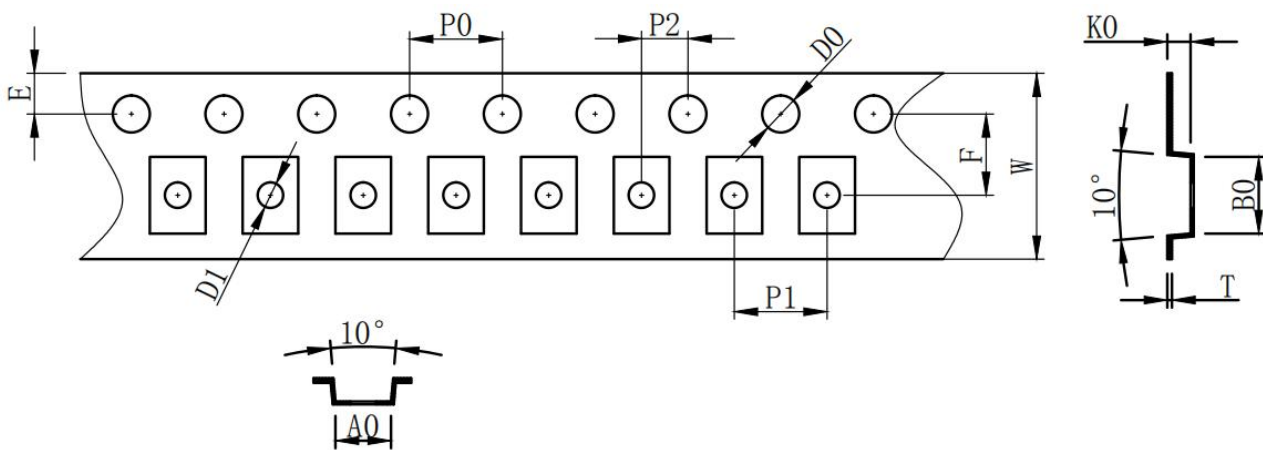
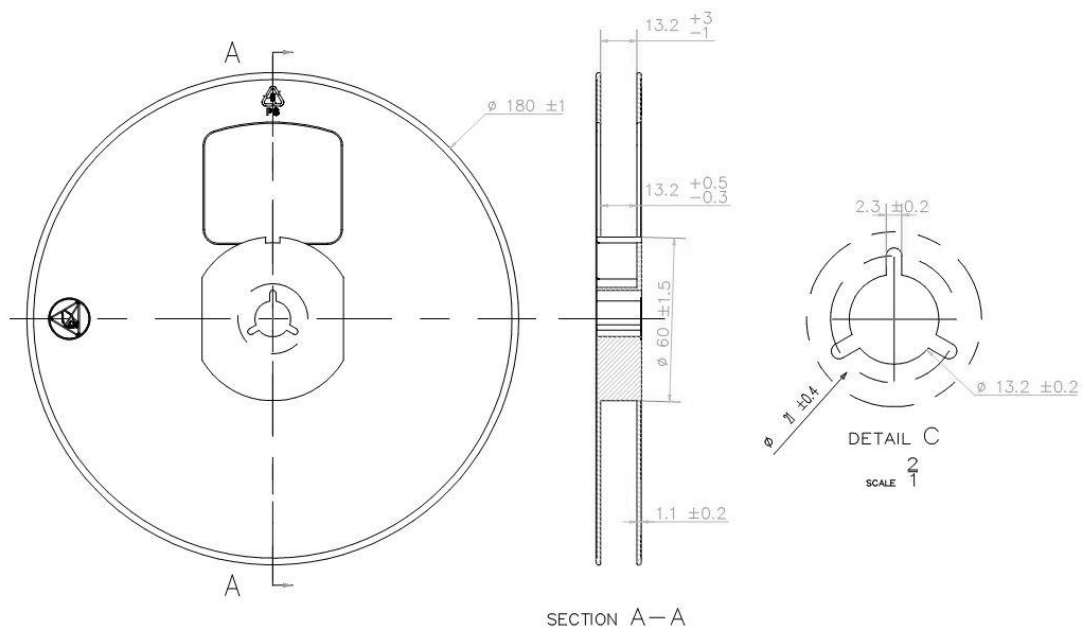

ITEM	W	A0	B0	K0	E	F	D0	D $\bar{1}$	P0	P1	P2	T
DIM	8.00	2.40	3.30	1.00	1.75	3.50	1.50	1.10	4.00	4.00	2.00	0.20
TOLE	+0.10 -0.10	+0.10 -0.10	+0.10 -0.10	+0.10 -0.10	+0.10 -0.10	+0.10 -0.10	+0.10 -0	+0.10 -0.10	+0.10 -0.10	+0.10 -0.10	+0.10 -0.10	+0.03 -0.03

包装信息-产品标签 | Packaging Information- Product Label

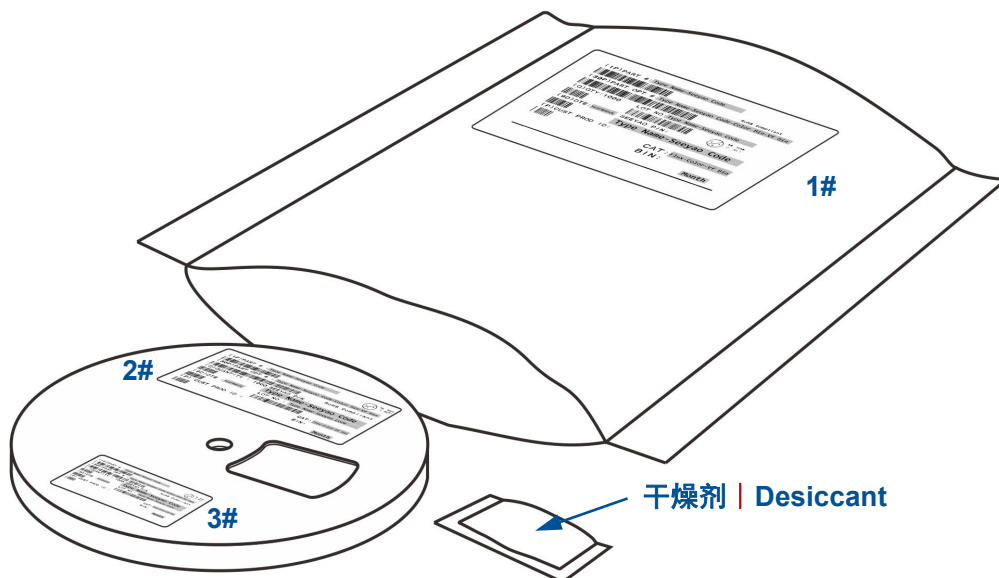

标签 1# | Label 1#

(1P) PART # : Type Name-Seeeyao Code
 RoHS Compliant
 (30P) PART OPT # : Type Name-Seeeyao Code-Color Bin-Vf Bin
 (Q) QTY : 1000 LOT NO : Type Name-Seeeyao Code
 (9D) DTE : Year&Week SEEYAO P/N :
 Type Name-Seeeyao Code
 (P) CUST PROD ID : CAT : Flux-Color-Vf Bin
 BIN :
 Month

标签 2# | Label 2#

(1P) PART # : Type Name-Seeeyao Code ML TEMP 2 260T
 (30P) PART OPT # : Type Name-Seeeyao Code-Color Bin-Vf Bin
 RoHS Compliant
 (Q) QUANTITY : 1000 SEEYAO P/N :
 Type Name-Seeeyao Code
 (9D) DTE : Year&Week LOT NO : Type Name-Seeeyao Code
 (P) CUST PROD ID : CAT : Flux-Color-Vf Bin
 BIN :
 Month

标签 3# | Label 3#

DT: 0123456789
 Num: 1000
 Bin: Bin012#
 ABCDEF-GH0123456789
 SALME0123456789
 Bin0123456789012345

修订记录 | Revision History

Version	Subject	Date
1.0	初版	2016
2.0	全面更新	2021/3/26